

19"/48cm HD-Ready LCD TV
FLU-1911S



20060803

Warnings and Precautions

To prevent any injuries, the following safety precautions should be observed in the installation, use, servicing and maintenance of this equipment.
 Before operating this equipment, please read this manual completely, and keep it nearby for future reference.



WARNING

This symbol is intended to alert the user to avoid the risk of electric shock.
 This equipment must not be disassembled by anyone except qualified service personnel.



CAUTION

This symbol is intended to alert the user to the presence of important operating and maintenance instructions in the literature accompanying the appliance.



To reduce the risk of fire or electric shock, do not expose this equipment to rain or moisture.

- TO REDUCE THE RISK OF ELECTRIC SHOCK,
- DO NOT REMOVE COVER (OR BACK).
- NO USER-SERVICEABLE PARTS INSIDE.
- REFER SERVICING TO QUALIFIED SERVICE PERSONNEL.



Use of controls, adjustments or performance of procedures other than those specified herein may result in hazardous radiation exposure.

Important Safety Instructions



This symbol indicates caution points.



This symbol indicates actions that should not be done.



This symbol indicates actions that must be performed.



- Do not place the equipment on any uneven or unstable carts, stands, tables, shelves etc. The equipment may fall, causing serious injury to children or adults and serious damage to the equipment itself.



- Use only a cart or stand recommended by the manufacturer. This equipment and recommended cart or stand should be handled with care. Quick stops, excessive force, and uneven surfaces may cause the equipment and cart/stand to overturn.



- Do not disable the 3-wire grounding type plug. The grounding pin on the 3-prong plug is an important feature. Removing the grounding pin will increase the risk of damaging the equipment.
- If you can not fit the plug into the electrical outlet, contact an electrician to install a grounding outlet.
- Always operate this equipment from the type of power source indicated on the rear of the serial/model plate.



- Never overload wall outlets and extensions.
- Use and handle the power cord with care. Do not place any heavy objects on the AC power cord.
- Do not pull the AC power cord. Do not handle the AC power cord with a wet hand.
- Do not touch the power cord and antenna cable during lightning.
- Remove the plug from the wall outlet, if the equipment will not be used for a long period of time.
- Do not place, use or handle this equipment near water.
- Never expose the equipment to liquid, rain, or moisture.
Seek for service if any of the above is spilled into the equipment.
- Do not expose the equipment to extreme temperature or to direct sunlight, as the equipment may heat up and suffer damage.
- Do not install the equipment near any heat sources such as radiators, heat registers, stoves, or any other apparatus that might produce heat.
- Do not attempt to service the equipment yourself.
- Opening and removing the covers may expose you to dangerous voltage or other hazards and may void your warranty. Refer service to qualified personnel.
- Do not place or drop any other objects on top.
- Do not insert anything into the ventilation holes of your equipment.
Inserting any metal or flammable objects may result to fire or electric shock.



- Do not place the equipment on uneven or unstable carts, stands, tables, shelves etc. The equipment may fall, causing serious injury to children or adults and serious damage to the equipment itself.
Always place the equipment on the floor or on a surface that is sturdy, level, stable and strong enough to support the weight of the equipment.
- Do not block any ventilating openings. Leave an open space around the equipment.
Never place the equipment :
on a bed, sofa, rug, or any other similar surfaces; too close to drapes/curtains/walls, in a bookcase, built-in cabinet, or any other similar places that may cause poor ventilation.



- Always remove the power cord from the outlet before cleaning the equipment.
- Never use liquid or aerosol cleaners on the equipment.
Clean only with a soft dry cloth.

Antenna Safety Instructions

If an outdoor antenna is connected, follow the precautions below:



- An outdoor antenna should not be located in any area where it could come in contact with overhead power lines, or any other electric light or power circuits.
- When installing an outdoor antenna system, extreme caution should be taken to prevent contact with power lines. Direct contact with power lines may be fatal and should be avoided at all costs.

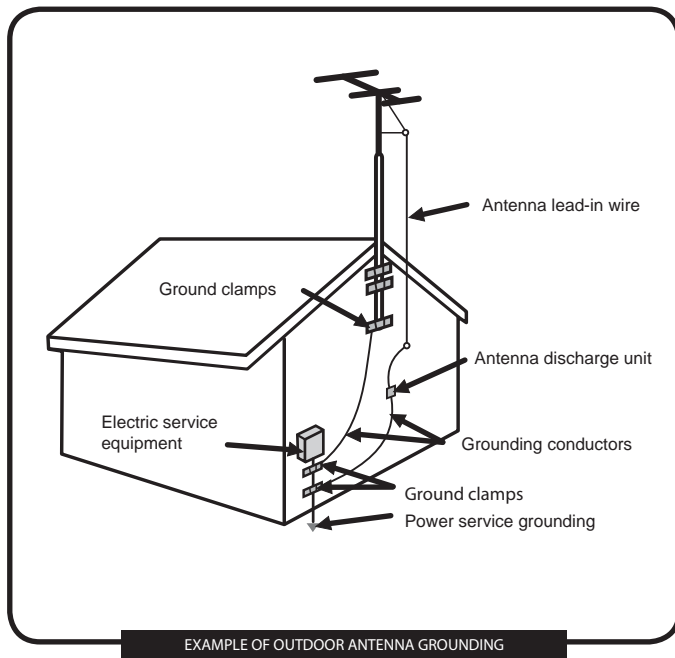

CONTENTS



■ Warnings and Precautions

Important Safety Instructions	2
Antenna Safety Instructions.....	4

■ Chapter 1 Introducing the LCD TV

Key Features	6
Package Contents	7
Setting Your LCD TV.....	8
Your LCD TV.....	9
Your Remote Control	11

■ Chapter 2 Installing the LCD TV

Connecting a TV Cable or an Antenna	13
Connecting an AV Device with Component (YPbPr/YCbCr) Connector.....	17
Connecting an AV Device with SCART Connector	18
Connecting a PC.....	19

■ Chapter 3 Using The Features

Operating the Menu.....	20
Customizing the VIDEO Settings.....	21
Customizing the AUDIO Settings.....	23
Customizing the SETUP Settings.....	24

■ Troubleshooting..... 26

■ Specifications 27

Chapter 1

Introducing the LCD TV

Key Features

Various Audio/Video terminals for external equipment connection

- 1 set of component Video/Audio input terminals
- 1 set of VGA/Audio input terminals
- 1 SCART input terminal
- 1 Headphone terminal

HDTV Component Video Inputs

- Offers the best video quality for DVD(480p) and digital set-top-box (HD1080i, 720p) connections.

Multimedia Enhanced Speakers

- True multimedia sound without external speaker. The LCD TV features two built-in 3w stereo speakers integrated into the stylish design.

High Contrast Ratio

- Colors will appear vibrant and lifelike producing superior image quality.

Wide Viewing Angle

- The 16:10 1440x900 widescreen gives wider view angles. You can view DVD films in native wide format for an enhanced multimedia experience and enjoy gaming action at full frame rates and higher wide-screen resolution.

Package Contents

ENGLISH

Make sure all of the following contents are included.

- LCD TV



- Remote Control/
AAA Batteries x 2



- Component Cable

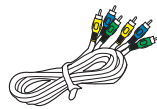

- AUDIO Cable



- Power Cord



- User Guide
- Quick Guide

These items are all you need to set up and operate the LCD TV in its basic configuration.



Make sure all of the following contents are included. If you are missing any items, please contact the distributor listed on your warranty card.

Setting Your LCD TV

Follow the instructions below to set up and install the LCD TV:

- 1** Use a supplied antenna cable to connect the VHF/UHF signal to the LCD TV's ANT. terminal (refer to page16).
- 2** Connect the AC power cord at the back of the TV and connect the power cord to wall outlet.
- 3** Insert the 2 batteries supplied in remote control.

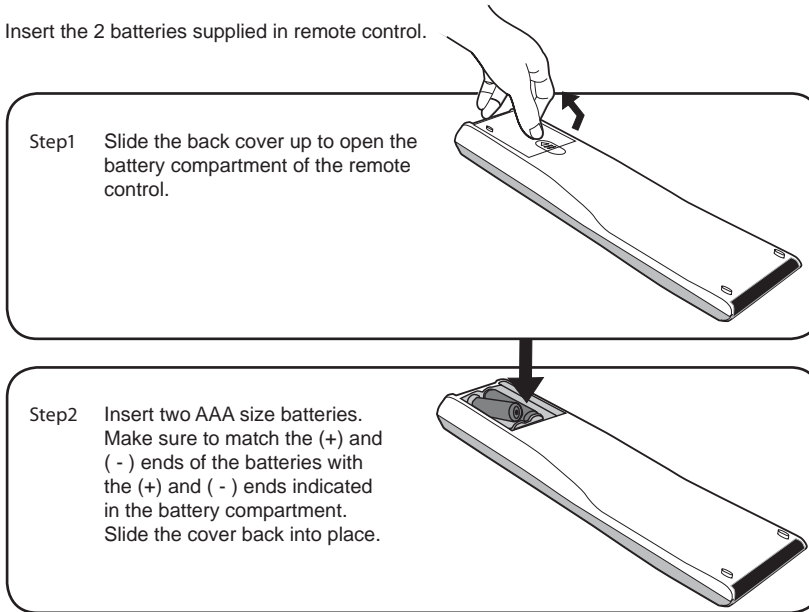

! Do not use caustic cleaners (porcelain, stainless steel, toilet, or oven cleaner etc.) on the remote, as it may suffer damage.

- 4** Connect to another external A/V device (refer to page17-18).

Your LCD TV

Front/Left Side View and Controls

ENGLISH

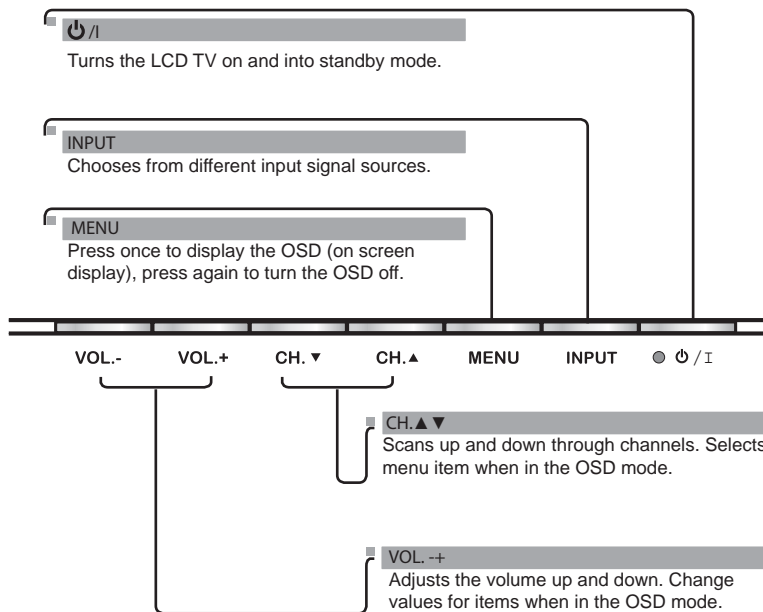
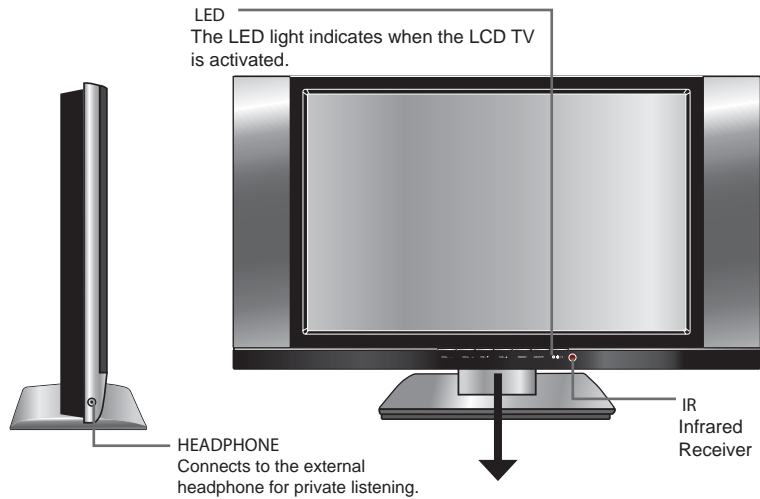

Rear View and Jacks

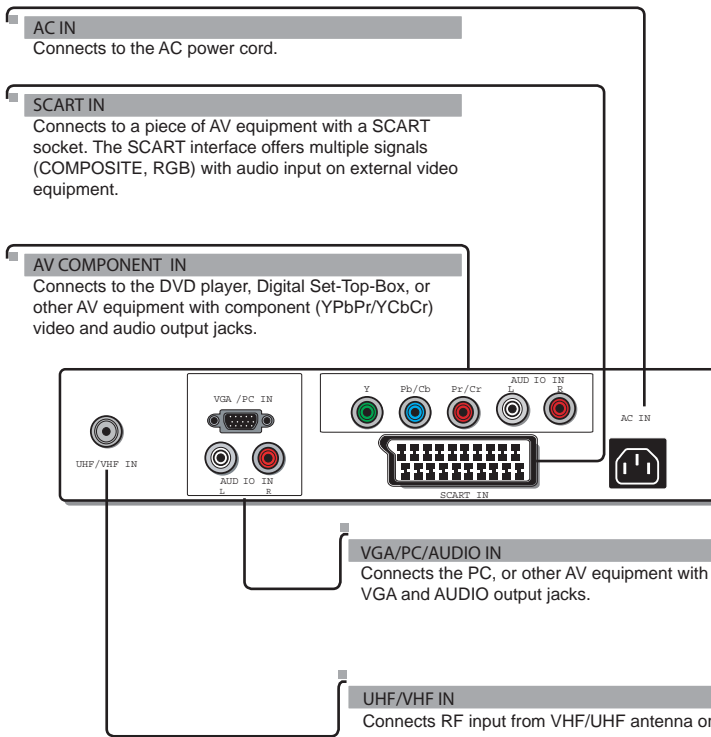
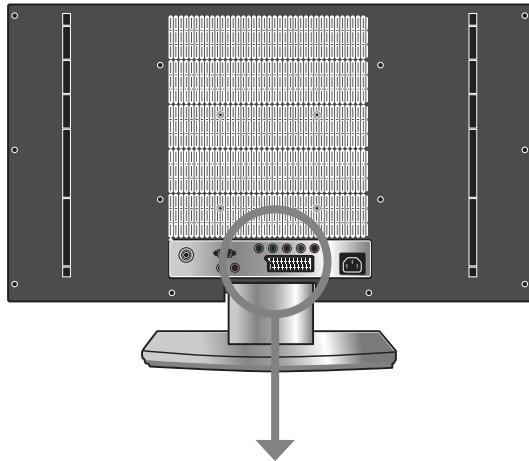



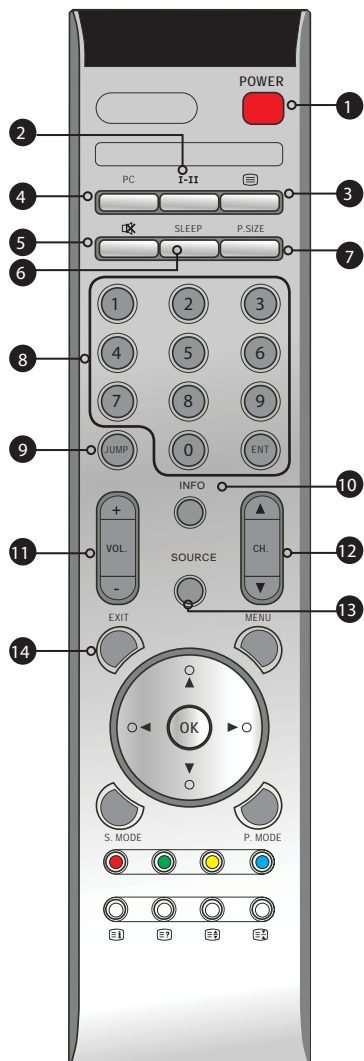

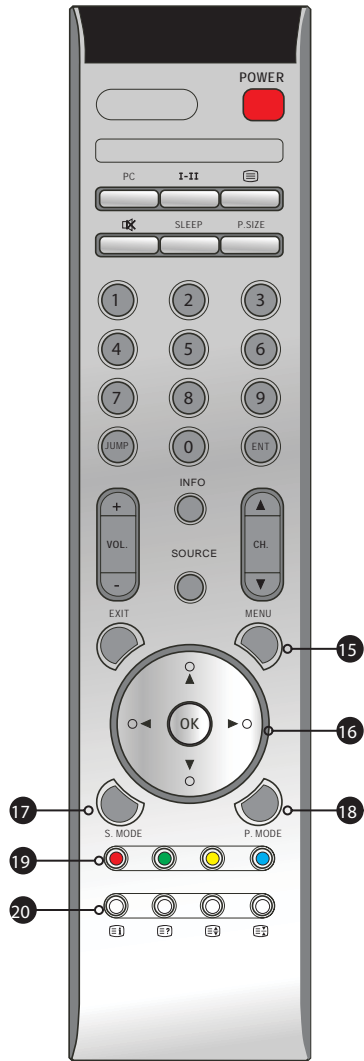

Your Remote Control



- | | | |
|-------|-----------------|---|
| 1 | POWER | Turns the LCD TV on and off. |
| <hr/> | | |
| 2 | I/II | Cycles through the TV Sound options: MONO/DUAL/STEREO |
| <hr/> | | |
| 3 | Teletext | Turns on and off the Teletext function. |
| <hr/> | | |
| 4 | PC | Pressing enter VGA mode. |
| <hr/> | | |
| 5 | Mute | Pressing once mutes audio. Pressing again restores audio. |
| <hr/> | | |
| 6 | SLEEP | Sets the LCD TV sleep time in TV/ SCART/COMPONENT/ mode. |
| <hr/> | | |
| 7 | P-SIZE | Selects from the following mode:16:9, 4:3 in TV/SCART/COMPONENT/ mode. |
| <hr/> | | |
| 8 | 0-9/ENT | Select and switch to a channel by using 0-9 buttons and ENT, or wait three seconds after entering a channel. |
| <hr/> | | |
| 9 | JUMP | Returns to previously selected channel. |
| <hr/> | | |
| 10 | INFO | Pressing once displays a variety of information such as the current channel and the input source. |
| <hr/> | | |
| 11 | VOL.+/- | Increases and decreases volume. |
| <hr/> | | |
| 12 | CH.▲▼ | Change channel up and down. |
| <hr/> | | |
| 13 | SOURCE | Pressing SOURCE repeatedly to select the video equipment connected to the video inputs of your LCD TV: TV/ SCART/COMPONENT/VGA. |
| <hr/> | | |
| 14 | EXIT | Exits the OSD menu. |



- 15 MENU.....Displays the OSD menu on the screen.....
- 16  OK Cycles through OSD options and selects individual menu items. OK confirms option settings.....
- 17 S.MODE Selects sound effect: POP / Rock / Live /Custom
- 18 P.MODE Selects picture mode: Normal / Vivid / Sports / Nature.
- 19  Accesses the TELETEXT items or corresponding pages in TELETEXT mode.....
- 20  Displays the main index in TELETEXT mode.
-  Reveals hidden information such as the answer to a quiz in TELETEXT mode.
-  Displays the top, bottom or all of page, to easily read in TELETEXT mode.
-  Freezes a multi-page passage on screen in TELETEXT mode.



Effective range:
The remote can control the LCD TV from up to 5m away, if pointed directly at the receiver.

Chapter 2

Installing the LCD TV

Refer to the owner's manual of any external equipment to be connected.
When connecting any external equipment, do not connect any AC power cords to wall outlets until all other connections are completed.

ENGLISH

Connecting a TV Cable or an Antenna

Antenna Connection

The antenna requirements for good color TV reception are more important than those for a black & white TV reception. For this reason, a good quality outdoor antenna is strongly recommended. The following is a brief explanation of the type of connection that is provided with the various antenna systems.

- A 75-ohm system is generally a round cable (not included) with PAL-type connector that can easily be attached to a terminal without tools.

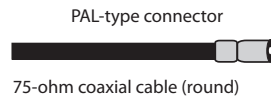

- A 300-ohm system is a flat twin-lead cable (not included) that can be attached to a 75-ohm terminal through a 300-75-ohm adapter (not included).

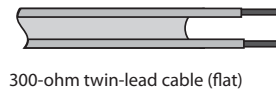

Use one of the following two diagrams when connecting an outdoor antenna.

A. Combination VHF/UHF antenna

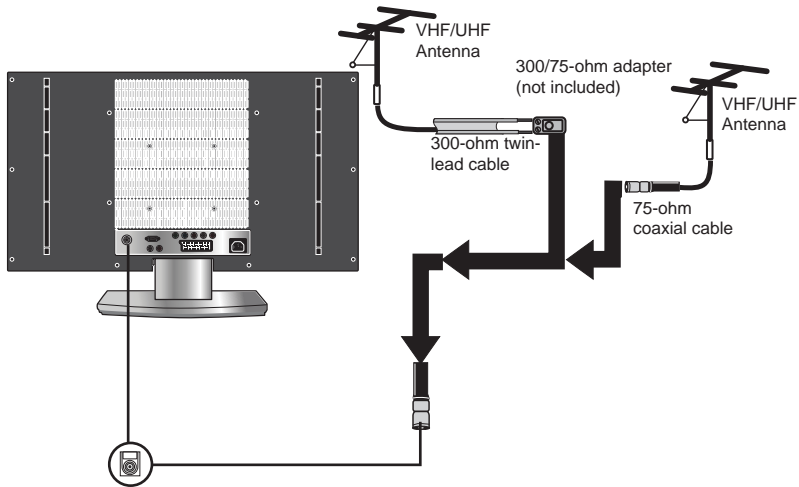

B. Separate VHF and/or UHF antennas

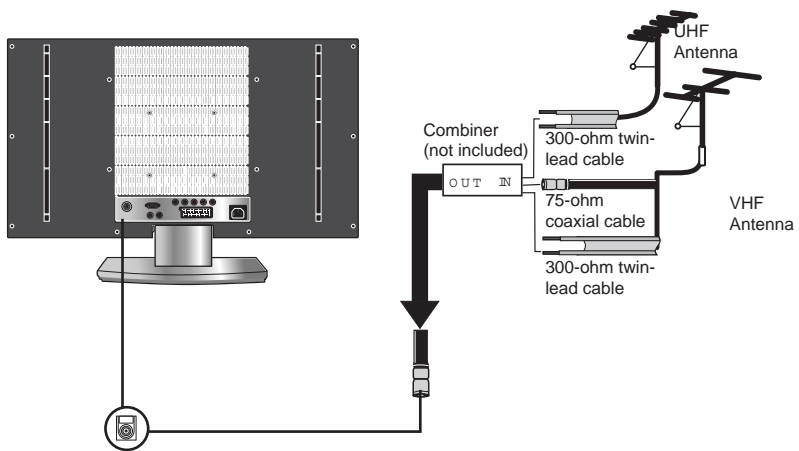

Cable TV (CATV) Connection

The cable ground shall be connected to the grounding system of the building accurately, or as close to the point of cable entry as possible. Use of this TV for other than private viewing of programs broadcasted on UHF, VHF or transmitted by cable companies for the use of the general public may require authorization from the broadcast/cable company, and/or program owner.

- A 75-ohm coaxial cable connector is built into the set for easy hookup. When connecting the 75-ohm coaxial cable to the set, connect the 75-ohm cable into the ANT. terminal.
- Some cable TV companies offer premium pay channels. Since the signals of these premium pay channels are scrambled, a cable TV converter/descrambler is generally provided to the subscriber by the cable TV company.

This converter/descrambler is necessary for normal viewing of scrambled channels. (Set your TV to channel 3 or 4, typically one of these channels is used. If this is unknown, consult your cable TV company.)

For more specific instructions on installing cable TV, consult your cable TV company. One possible method of connecting the coverter/descrambler provided by your cable TV company is shown in the diagram below.

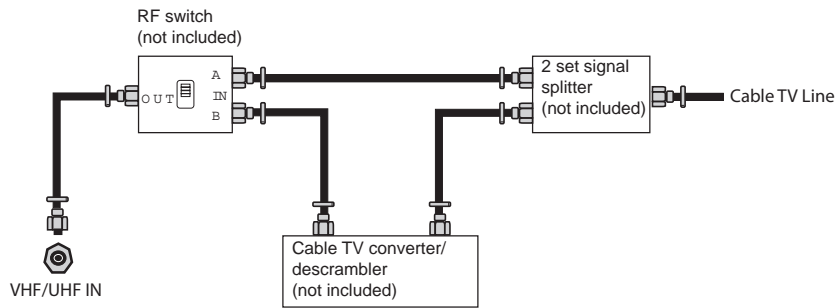

- ⚠ The RF switch (not included) is required to provide two inputs (A and B). Setting the RF switch to position A allows viewing of all unscrambled channels by using the TV channel keys.
- Setting the RF switch to position B allows viewing of all scrambled channels via the converter/descrambler by using the converter channel keys.

1

METHOD A:

Use a supplied antenna cable to connect to the LCD TV's TV UHF/VHF terminal.

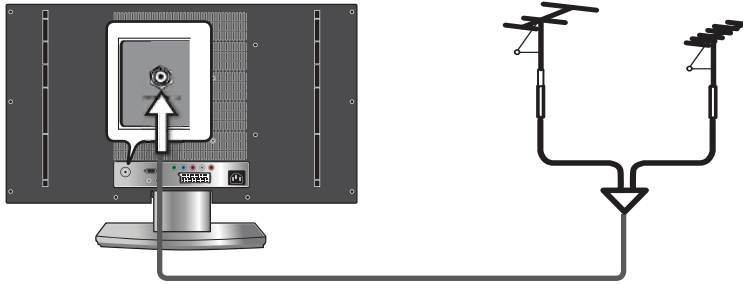

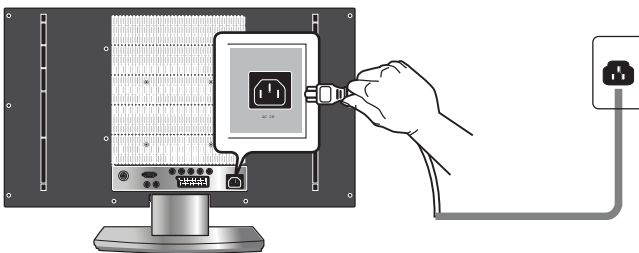

2

Connect the AC power cord at the back of the TV and connect the power cord to wall outlet.



3

Press the  button on the remote to turn on the LCD TV.

 Always disconnect the LCD TV from the main voltage when the LCD TV will not be used for a long period of time. The  button on the front panel is only used for switching the LCD TV into standby, it does not disconnect the device from the main voltage. To completely disconnect the main voltage, please remove the power plug from the socket.

4

Press the INPUT button repeatedly on the remote to select input signal source.

Connecting an A/V Device with Component(YPbPr/YCbCr) Connector

1

Use a component cable to connect the external A/V device's component output jacks to the LCD TV's YPbPr(YCbCr) IN input jacks.
Use an audio cable to connect the external A/V device's component audio jacks to the LCD TV's audio input jacks.

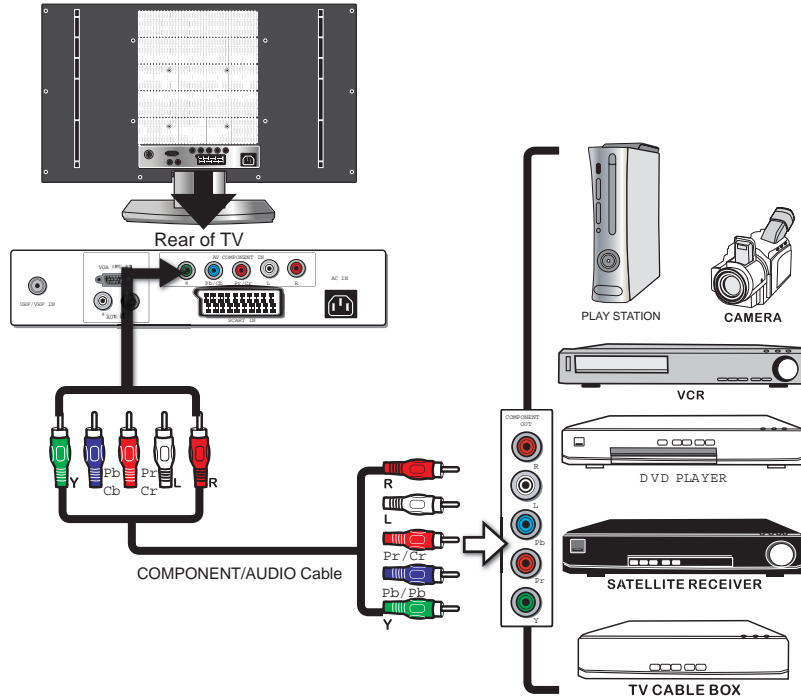

Not all A/V device have the ability to connect to a TV. Please check your A/V device user guide for compatibility.

2

Connect all AC power sources, before turning on the power switch of the LCD TV or other connected equipment.

3

Press the  button on the remote to turn on the LCD TV.

4

To view the A/V device's with component input, press the Input button on the remote to select COMPONENT.



The component video jacks on your A/V device are sometimes labeled YPbPr, or YCbCr. For an explanation of component video, see your DA/V device's user guide.

ENGLISH

Connecting an A/V Device with SCART Connector

- 1 Use a SCART cable to connect the external A/V device's SCART socket to the SCART socket.

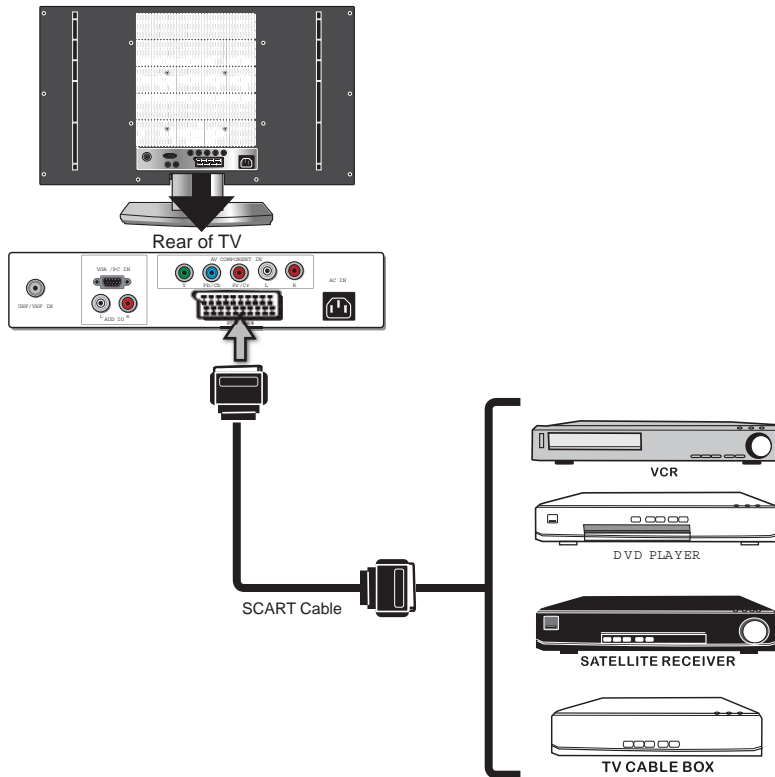



! The SCART socket offers a multi-signal interface, including C-Video input, RGB input, audio input.

- 2 Connect all AC power sources, before turning on the power switch of the LCD TV or other connected equipment.
- 3 Press the **POWER** button on the remote to turn on the LCD TV.
- 4 To view the A/V device's with component input, press the Input button on the remote to select SCART.

Connecting a PC

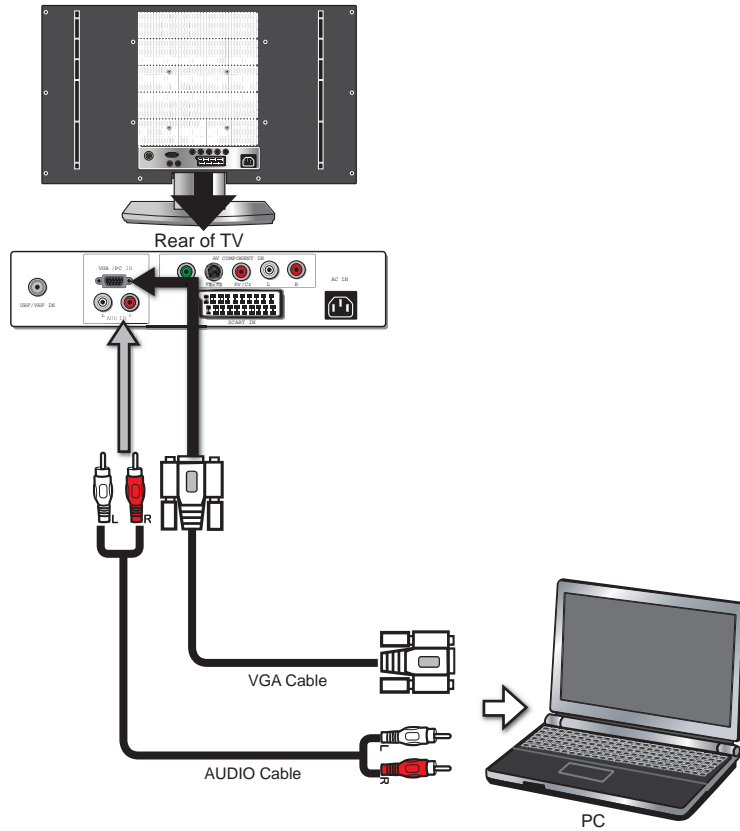
- 1 Use a VGA cable to connect the PC's VGA output jack to the LCD TV's VGA input jack. Use an audio cable to connect the PC's audio output jacks to LCD TV's VGA audio input.



- 2 Connect all AC power sources, before turning on the power switch of the LCD TV or other connected equipment.
- 3 Press the  button on the remote to turn on the LCD TV.
- 4 To view the A/V device's with component input, press the Input button on the remote to select VGA.

Chapter 3

USING THE FEATURES

Operating the Menu

1 Press the  button on remote control to turn the LCD TV on.

2 To select the signal source, press the MENU button on the remote control. The on-screen menu will appear on the screen. Use the ▲▼ buttons to highlight your main menu option, then press OK to enter your selected option.

VIDEO MENU:

Allows you to make adjustments to your picture settings.

- If the signal source is VGA, the VIDEO MENU appears as:
- If the signal source is TV/SCART/COMPONENT, the VIDEO MENU appears as:

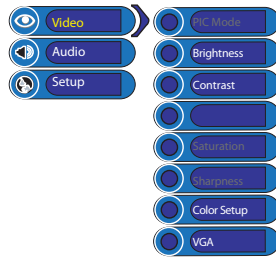

AUDIO MENU:

Allows you to customize the audio options and effects.



SETUP MENU:

Allows you to set up a variety of features: Language, , factory reset, channel, sleep timer.

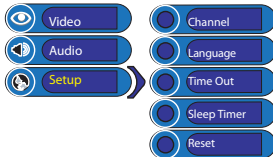

3 Use the ▲▼ buttons to select an option of the sub-menu. While in adjustment mode, and use the ◀▶ buttons to change the value of the item.

4 Press the EXIT button to exit the menu.

Customizing the VIDEO Settings

- 1 Press the **POWER** button to turn the LCD TV on.
- 2 Press the **MENU** button on the remote control to display the Main menu, and use the **▲▼** buttons to select the **VIDEO**, then press **OK** to enter the **VIDEO** option.
- 3 Use the **▲▼** buttons to highlight an individual **VIDEO** option, use the **◀▶** buttons changes the setting, and press the **EXIT** exits the menu.

- If the signal source is **TV/SCART/COMPONENT**, the **VIDEO** MENU appears as:

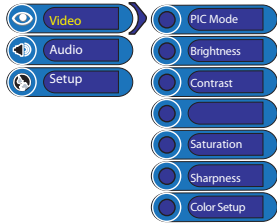

- 4 The **VIDEO** menu includes the following options:

PIC Mode	Cycles among display types: Normal/Vivid/Sports//Nature
Brightness	Controls the overall brightness of the picture.
Contrast	Controls the difference between the brightest and darkest regions of the picture.
Saturation	Controls the color intensity.
Sharpness	Increase this setting to see crisp edges in the picture; decrease it for soft edges.
Color Setup	Adjusts color components independently to achieve a warm or cool effect: Cool/Warm/User

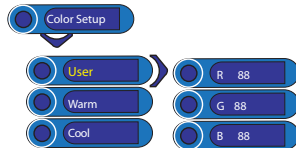

- **User:** Allows the user to adjust red, green and blue color component levels independently.
- **Warm:** Increases red tint
- **Cool:** Increases blue tint

- 5 ▪ If the signal source is VGA, the VIDEO MENU appears as:



The VIDEO menu includes the following options:

Brightness Controls the overall brightness of the picture.

Contrast Controls the difference between the brightest and darkest regions of the picture.

Color Setup Adjusts color components independently to achieve a warm or cool effect: Cool/Warm/User

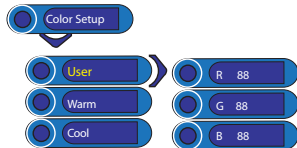

- **User:** Allows the user to adjust red, green and blue color component levels independently.
- **Warm:** Increases red tint
- **Cool:** Increases blue tint

VGA Press ▼ to display the VGA selection List: Auto setup/Position/Phase/H Size.



- **Auto Setup**
Press ▲▼ to select Yes, automatically adjust the display settings to optimize performance based on the VGA mode.
- **Position**
Controls the horizontal and vertical position of the picture.
- **Phase**
Controls the signal phase, which can improve focus clarity and image stability based on the VGA mode.
- **H Size**
Adjusts the width of the picture based on the VGA mode.

Customizing the AUDIO Settings

- 1 Press the  button to turn the LCD TV on.
- 2 Press the MENU button on the remote control to display the Main menu, and use the ▲▼ buttons to select the AUDIO, then press OK to enter the AUDIO option.
- 3 Use the ▲▼ buttons to highlight an individual AUDIO option, use the ◀▶ buttons changes the setting, and press the EXIT exits the menu.



- 4 The AUDIO menu includes the following options:

Volume	Controls the volume.
Bass	Controls the relative intensity of lower-pitched sounds.
Treble	Controls the relative intensity of higher pitched sounds.
Balance	Adjusts the relative volume of the speakers in a multiple speaker system.
Mute	Allows you to mutes and restore your LCD TV sound.
Sound Effect	Allows selection of an audio-enhancement technique from among the following options: Custom/Live/POP/Rock

Customizing the SETUP Settings

- 1 Press the  button to turn the LCD TV on.
- 2 Press the MENU button on the remote control to display the Main menu, and use the ▲▼ buttons to select the SETUP, then press OK to enter the SETUP option.
- 3 Use the ▲▼ buttons to highlight an individual SETUP option, use the ◀▶ buttons changes the setting, and press the EXIT exits the menu.

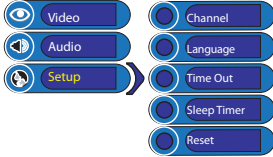

- 4 The SETUP menu includes the following options:

Channel

Press ▼ to display the Channel List: Auto Search/Tv Setup/Channel Swap/Channel Name/Fine Turn/Add/Erase/Reset.



- **Auto Search**
Press ▼ to select Yes, Auto Search automatically creates a list of receivable channels (the list cannot be created if interrupted).
- **Tv Setup**
Select a TV system from the country: Auto/Pal/SECAM.
- **Channel Swap**
Changes the TV station channel location.
- **Channel Name**
Edits your channel labels.
- **Fine Tune**
Allows adjustment for the fine tune level by hand if signal is too weak or picture is blurry.
- **Add/Erase**
Add/remove channels.
- **Reset**
Clears all channel settings.

Language	Selects to display all on-screen menus in your language of choice: ENGLISH, DEUTSCH, FRANCAIS, ESPANOL, ITALIANO, PORTUGUESE, POLAND, NETHERLAND.
Timer out	Allows selection of the display time of the on-screen menu: 5, 15, 20, 25, 30 seconds, or off.
Sleep Timer	Allows selection of the time that elapses before the TV shuts off automatically: Off/15/30/45/60/90/120 minutes.
Reset	Restores factory settings.

ENGLISH

TROUBLESHOOTING



Before consulting service personnel, check the following chart for a possible cause of the trouble and for a possible solution.

TV will not turn on

- 1 Make sure the power cord is plugged in, then press the  button on the remote.
- 2 The batteries in the remote control may be exhausted.
- 3 Replace the batteries.

No picture, no sound

- 1 Check the interface cable between TV and antenna/cable TV.
- 2 Press the  button on the remote.
- 3 Press the INPUT button on the remote repeatedly to select the connected video sources.

Poor picture, sound OK

- 1 Check the interface cable between TV and antenna/cable TV.
- 2 Try another channel, the station may have broadcast difficulties.
- 3 Adjust the Brightness/Contrast options in the VIDEO Menu.

Picture OK, poor sound

- 1 Sound may be muted. Press the  button on the remote.
- 2 Press the VOL+ button to increase the volume.

Audio noise

- 1 Move any infrared equipment away from the TV.

SPECIFICATIONS

ENGLISH

MODEL		FLU-1911S
LCD Panel	Panel Size	19"/48cm TFT LCD
	Brightness	400
	Contrast Ratio	500:1
Max. Resolution		1440x900
TV System		PAL-I/BG/DK/SECAM LL'
Input Connector	YPbPr/AUDIO(L/R)	1
	VGA/AUDIO(L/R)	1
	SCART	1
	HEADPHONE	1
Power Source		AC100~240V, 50/60HZ, 1.2A
Power Consumption		42 W, standby < 3 W
Dimension(W X D X H)		573 x 171 x 371.8 mm
WEIGHT		12.3 LB

